

# Man-machine clanks into step

Mark Witkowski of the AI Laboratory at Queen Mary College looks at the principles of robotics design and discusses some ways in which amateurs can learn from the pros.

IN PART ONE of this introduction to robotics (February 1980 *Practical Computing*, we looked at some of the ways in which robots are slowly turning a dream into reality.

This month, Part Two deals with some of the mechanical design considerations in robotics.

Robots were defined as mechanical contrivances with some human-like attribute or, preferably, attributes. Given the current 'state-of-the-art' in robotics, it is unusual for any serious attempt to be made at constructing a humanoid, mechanical-man type of machine.

Manipulator designs loosely based on the human arm are not uncommon, but machines that walk are much rarer. Walking in a straight line is quite feasible, and even walking up stairs, but turning corners and walking over rough ground is another matter.

Walking locomotion is very much a matter of dynamic system control, as the mass of the body must be balanced against both gravity and its own momentum.

The Russians and Japanese are the most active in this area. WABOT, made in the Waseda University Bio-engineering department in Japan is a hydraulic-powered biped walking machine (Kato *et al* 73).

Several papers relating to walking can be found in the proceedings of the two international CISM-IFTOMM symposia — at Udine in 1973 and Warsaw in 1976. They include theoretical and practical studies of biped, quadruped and six-legged locomotion.

A common robot vehicle configuration, currently thought of as the best compromise encompassing all the conflicting design and control problems, is that of a motorised based sporting one or more arm-type manipulators.

If the robot is not to be controlled by a person holding a joystick while watching the vehicle directly, it must also have one or more television cameras on board. These will sometimes feed a digitiser to allow computer analysis of the scene.

A reasonable goal to aim for in robotics research is to develop a totally autonomous robot under computer control.

Even if this is not how robots will eventually be used, it means that a number of currently unsolved problems relating to the control and behaviour of robots will have to be tackled. They can all too easily be glossed over when a person demonstrates the capabilities of a robot by remote control in the laboratory or workshop environment.

Because of the time taken and the expense involved in designing, building, commissioning and programming a useful, general-purpose robot of even quite modest specification, it is a game for a team rather than the individual.

But a micro-mouse or turtle-type robot is well within the capabilities of the individual and a number of books describing in full detail the mechanical and electronic design of a small mobile robot are available.

For instance, full constructional details are

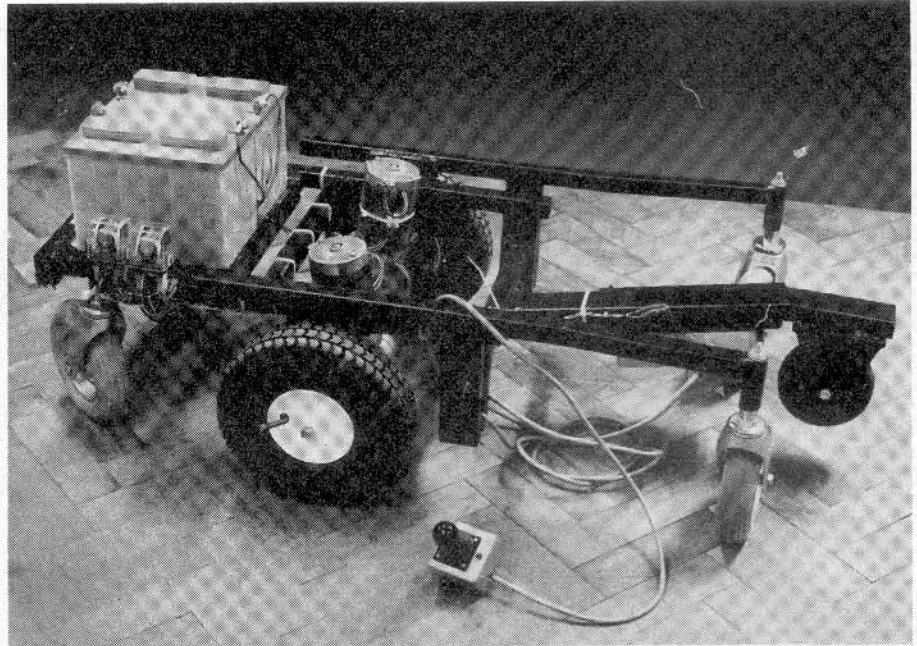

Picture 1: General lay-out of wheelchair base, showing near-central location of drive wheels. This machine is capable of climbing a 3/4 in kerb.

given by Tod Loofbourrow for his robot 'MIKE' in the book *How to build a computer-controlled robot* (Loofbourrow 78). Computing is provided on-board by a KIM-1 microprocessor.

Another amateur constructional robot design book is David Heiserman's *Build your own working robot* (Heiserman 76). In this machine — 'BUSTER' — control was provided by hard-wired logic rather than a microprocessor. Either might form the basis of a personal design.

## Copy a design

It makes sense to start by copying an existing design that can reasonably be expected to perform to some specification before extending and modifying it to your own requirements.

These modifications may range from simple changes to the control algorithms, or adding new sensors more appropriate to the project; to a substantial re-build with major mechanical additions, such as a manipulator or dumper-truck type pallet.

There are few books about robotics in general, so the information required will often have to be gleaned from many different sources. One general review of the technical aspects of robotics can be found in John Young's book *Robotics* (Young 73).

Much of the work to be discussed this month has been done at universities around the world. Some comes from the research labs of larger companies, but mostly the mechanical aspects of robots are best covered by standard industrial design principles. This is the route

most industrial robot manufacturers will take.

Their work will be governed by standard, well-understood and sound engineering knowledge and practices. This, in itself, is no bad thing: cost-effectiveness, reliability and usability are all pertinent factors.

Sophisticated sensor design and computer control are often treated with the utmost suspicion by industrial roboticists and will therefore only be used by them if all other possible solutions prove unsuccessful.

But in the long term, these will have to be introduced as robots are required to perform tasks requiring higher levels of skill than are currently possible.

A practical mobile robot will almost certainly be based on a platform powered by two independently controlled motors and some passive castors to maintain balance.

Ackerman steering, as used on cars, has occasionally been used, notably on vehicles for space and extra-terrestrial exploration. One, loaned by the Marshall Space Flight Centre to the Jet Propulsion Laboratory (JPL) had double Ackerman steering (steering on both front and rear wheels) with each of the four wheels independently powered (Lewis and Bejczy 73 and Dobrotin and Scheinman 73).

For more mundane, earth-bound vehicles, the Ackerman steering principle requires a complex system of linkages and is hard to control in confined spaces or where there are many closely-packed obstacles to avoid.

Most small mobile robots have two drive wheels along the central axis of a nominally circular body, though groundplans are often square or hexagonal. Then the castor forms a

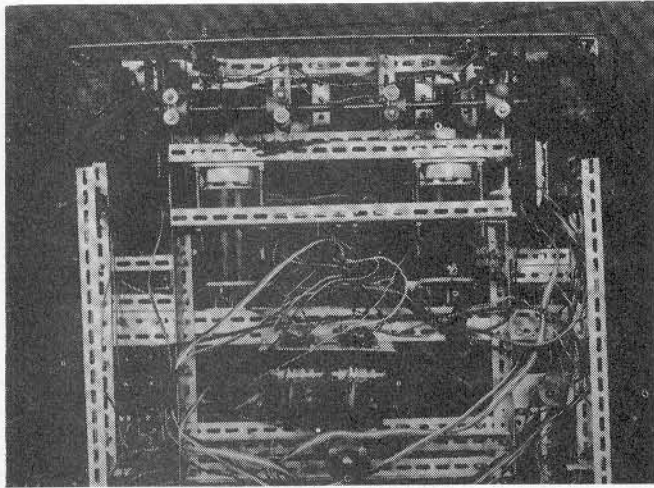

**Picture 2: Modified drive/steering configuration better suited to front alignment operations such as pallet lifting.**

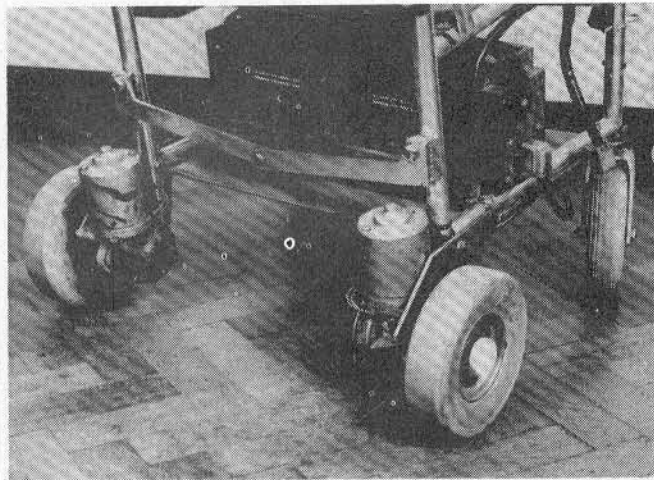

**Picture 3: Standard wheelchair layout with driving wheels at the rear, as used on the University of California's 'JASON'.**

triangular balance point — the weight of the batteries and electronics being used to ensure that the vehicle does not fall over (fig. 1a, p87).

Steering is achieved by driving the two wheels in different directions and/or at different speeds. By powering them both forward equally, the vehicle will travel in a straight line forwards; if both motors are reversed, the machine will travel backwards.

If one wheel goes one way and the second the other the base rotates about its centre point. By varying the ratios of motor speed, the vehicle spins about a point on a line between the wheels. If the motors are rotated in different directions, it describes an arc whose radius and direction depends on the ratio of rotation speeds and directions of both motors.

## Every which way

'NEWT' (Hollis 77) used this configuration. The wheelchair base shown in **photograph one** has its driving wheels (almost) central. Notice the four castors support the weight evenly — the front two are hinged near the motor bearings. These and the wheeled projection at the front allow the vehicle to climb curbs up to 3½in high. This wheelchair base is to form the chassis of a new robot vehicle.

Castors of this form, where a wheel is used in an angled bracket, have a disadvantage because they tend to steer the vehicle in an unpredictable way until they realign themselves after each change of direction.

**Figure 1b** shows a modification to this standard layout (**photograph two**). Here the wheels are at the front. Steering and general

controllability are similar to 1a. There is a slight advantage if the front edge of the vehicle has to be lined up with objects in the environment such as battery contacts on the robot's front that have to be aligned with a battery charger power source on the wall.

This layout should be considered if the robot is to be used in pallet shifting operations. The vehicle would be fitted with a 'fork-lift' attachment on the front and objects to be moved would be placed on pallets or low stilts. An object would be moved by running the fork-lift between the stilts and lifting the prongs — a task typical of most industrial warehousing.

A disadvantage of this system compared with 1a is that it naturally spins about a point very near the front of the base and as a result can be quite difficult to extricate with simple software if it gets trapped in a tight corner.

**Figure 1c** shows the last configuration with driving wheels at the rear. This is the standard wheelchair layout (**photograph three**). 'JASON', built at the University of California at Berkeley, used this principle (Smith 73).

As a layout it offers neither easy leading edge positioning, as in 1b, nor the 'escape' facility of 1a. It is better suited to travelling over longish distances in a forward direction, where abrupt changes of direction are unusual. Its use therefore is best suited to uncluttered environments, as would be the Ackerman steering principle.

Loofbourrow's 'MIKE' has two forward-facing drive wheels at the rear corners of a triangular base and steers by pointing a third wheel at the apex of the triangle in the desired

direction. This layout seems to cost an extra motor for no particular advantage.

With all these layouts, 'forward' and 'backwards' are somewhat arbitrary, since the motors have to be bi-directional. It is the direction in which the cameras and the majority of the obstacle-detecting sensors point that really fixes the most significant direction.

These vehicles are almost always powered by low voltage d.c. electric motors, whose exact specifications will depend on the size, weight and performance required from the robot in relation to the tasks it will have to perform.

In general, d.c. motors work at high speed and low torque; but in a robot, low speed and high torque are required. Fortunately reduction gearing produces exactly this transformation.

## Getting motorised

**Photograph four** shows four different motors. On the left is a Meccano six-volt motor with an integral six-speed reduction gearbox. In the centre is a six-volt model motor, with a 0.6amp free-running and seven-amp stalled rating.

Above and to the right of this motor are a selection of in-line sun and planet reduction gears for this motor. The gearboxes come in a selection of ratios from 2:1 to 6:1 and they can be stacked to provide any integer ratio.

A pair of these motors can be seen in **photograph two**; the output shafts of the motors feed a 5:1 box before a 20:1 worm drive gear on the wheel axles. Worm gears form an effective one-way mechanical linkage. The wheels will not turn if the motors are not powered, which is useful for instance for holding the vehicle on a slope. The foam-tyred wheels as well as the motors are available from most hobby model and radio control suppliers.

Below the motor, in the centre of **photograph four**, is a smaller one in the same series (6V, 100mA running, 500mA stalled). High levels of electrical noise generated by the Meccano motor make it unsuitable for computer-controlled robot drives, since they upset all but the most isolated and noise-suppressed logic circuits.

The motors on the wheel-chair (**photograph three**) are similar to those used for the windscreen wipers on cars. Clearly they are powerful enough to drive the weight of two car batteries and a fully grown man through their internal reduction gearboxes.

An uprated version of this motor type is used on the base in **photograph one**. Top speed is about four miles an hour, fully laden with a man, and that can be alarmingly fast!

D.c. motors are not very easy to control to a high level of precision, but they are cheap, readily obtainable in a myriad different sizes and specifications with a quite adequate power-to-weight ratio. It is usual to control the speed and power output of d.c. motors by pulse-width modulation of the input current, rather than by varying the voltage levels at the terminals.

This is easy to arrange with small logic circuits or equally trivial microprocessor programs (Computabits 79a). **Figure 2** shows a bridge circuit that allows a d.c. motor to be run in either direction from a single voltage source.

Each of the transistor pairs A (Q1,Q2), B (Q3,Q4), C (Q5,Q6) and D (Q7,Q8) form a darlington pair (equivalent to a single transistor with a high current gain), that can be switched from 'off' to 'on' with TTL logic levels.

With the circuit logic inputs unplugged and TTL inputs default to high, a logic zero appears at the bases of Q5 and Q7, which means that switches C and D are non-conducting. The logic zero at the bases of Q9 and Q10 means that they are non-conducting, therefore a logic one appears at the bases of Q1 and Q3, so switched A and B are 'on'.

While the circuit is in this state, both the '+' and '-' poles of the motor are at the positive motor drive potential, so, the motor is in effect shorted out — giving a degree of reactive braking. If switch A is put into its non-conducting state (P=0) and C is switched on (Q=0) the '+' pole is still at the positive rail but the '-' is at the zero rail and current flows C — motor-B and it rotates in one direction.

If A and D are switched on and B and C off then the '-' pole is at positive and the '+' pole at zero and current flows D motor — A and it rotates in the other direction.

While none, or only one, switch conducts, the motor is effectively isolated. While A and B or C and D are conducting, it is partially shorted. If A and C or B and D, or any three or all four conduct, the power rails will be shorted through the transistors and they will be destroyed. It would therefore be worth designing a small logic circuit that converted a FORWARD/REVERSE and an ON/OFF logic pair into the correct P,Q,R and S drive signals, rather than rely on a length of code to do this.

The diodes are for back e.m.f. protection and the circuit, with the values shown, will work for motors drawing up to eight amps. As each of the transistor switches drops about a volt, the power rail should be two volts higher than the motor voltage rating. At medium and high current flows the power transistors get hot, so heat-sinks are called for. The circuit is shown in photograph five.

## Mechanical construction

The overall size and shape of the finished robot may well be determined by the type of motor that is readily available or already to hand. There are no real guidelines about detailed mechanical construction, so a few pointers are called for.

Firstly, robust mechanical construction will always pay off in the long run. The robot in photograph two is constructed from 'Proto', which offers the same types of component as the familiar 'Meccano' construction system.

Meccano is not strong and rigid enough for load-bearing members but Proto can be bolted together to form a firm structure. Increases in robot size require corresponding upgrading in the strength of the individual structural parts.

Most robot vehicles, even the small ones, will clock the scales at surprisingly high weights, NEWT, for example, 30in high and 14in in diameter, weighs in at 60lb.

Since much of this weight will be transmitted to the wheel axles, these should normally be supported by proper bearings, rather than relying on the motor output shaft bearings.

Ample battery size is a crucial factor in determining the size of motor required. The vehicle must run for a period of several hours without recharging. Not only will the motors consume power, but electronic circuits, motor drivers, sensor systems, cameras and micro-processors will soon increase the power consumption.

With any form of computer-controlled robot, it is important to be able to determine

how far and how fast the robot is travelling. D.c. motors are not sufficiently predictable to allow open loop control; even repeating the same actions will seldom give similar results.

There are several techniques for measuring distance traversed and it is usual to servo the speed of the motor using an optical or magnetic disc that produces a frequency proportional to the angular velocity of the wheel. Gray code encoder discs can be used to give a reliable indication of axial rotation, which can then be integrated in software to give precise co-ordinate positions.

The only practicable solution to high positional accuracy and repeatability is to drive the wheels with stepper motors. NEWT uses a pair of 200 step/revolution motors driving wheels with neoprene Q-ring types (that don't slip on the floor surface) through a 3:1 reduction gearbox, offering a total of 600 steps per wheel revolution.

Each step causes the robot to move by about 0.5mm or to rotate by about 0.1 of a degree. Complicated sequences of movements involving up to 100 separate actions still give a repeatability of in.

Stepping motors should be capable of accelerating from rest to full speed under load and then decelerating to a halt if the inertia of the robot is not to stall then while speeding up or overrun while slowing down, causing a loss of accuracy in either case.

Photograph six shows two different stepping motors, on the left a 15 degree/step, 28 volt, 38 ounce/inch motor and on the right a 200-step (1.8 degree) 25 ounce/inch motor. The circuit shown acts as a power driver for any four-

phase motor. The gear box is a 60:1 reduction worm-drive unit, with a built-in anti-backlash mechanism.

Further information on stepper motors and using them can be found in *Computabits 79b* and Giacomo 79, and Ralph Hollis gives the driver circuits for NEWT in Hollis 77.

Arm, manipulator and gripper designs present a different selection of problems. The photographs of industrial robot arms in Part One will give a general idea of the patterns in common use.

## Robot body image

Any arm that is to have more than one special use must have certain characteristics (see: Burckhart and Helms 76). There must be sufficient degrees of freedom (joints, extensions etc) to allow the arm to manipulate objects into several orientations within a good volume of space.

It must have sufficient power to not only lift its own weight, at the most disadvantageous extension and orientation, against gravity, but that of some payload as well.

Provision must be made during the design stage to allow adequate sensing if the arm is to be computer-controlled. Dead reckoning open-loop control is only suitable for highly engineered devices with precise actuators.

The arm should be constructed to sufficiently fine tolerances so as to be rigid while stationary and also to give precise motions without backlash or oscillation when it moves.

Figure 3 shows the most commonly used types of motion, which, for the sake of

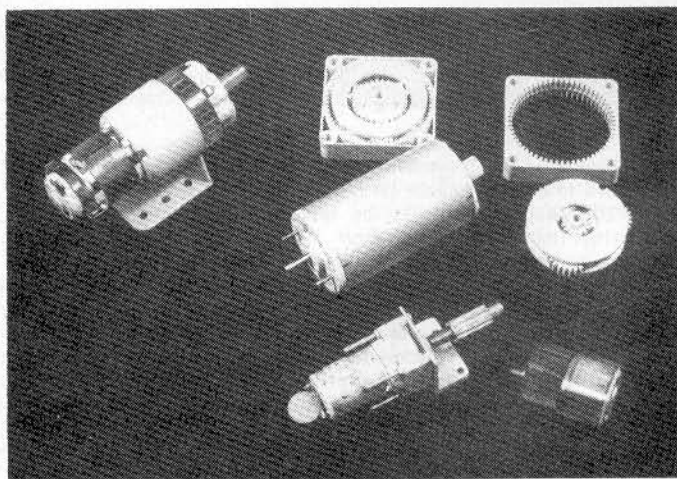

Picture 4: A selection of 6V motors with epicyclic gearbox components. Note that these motors can upset microprocessor controls unless electrical noise is properly suppressed.

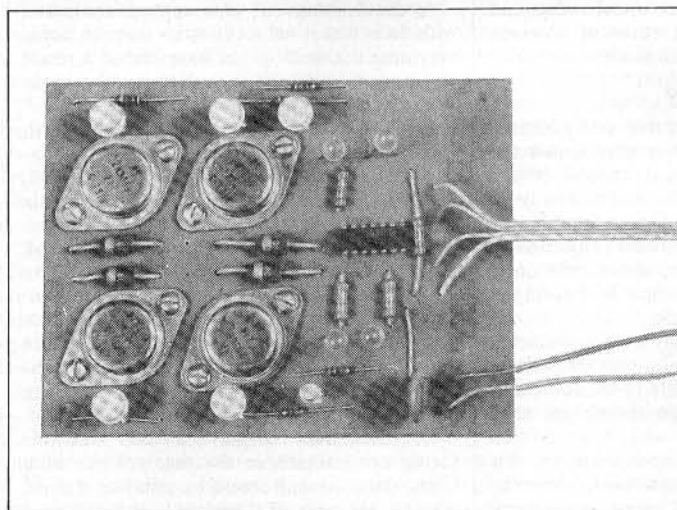

Picture 5: Completed version of the bridge circuit shown in figure 2. This permits a d.c. motor to be driven in either direction from a single voltage source. Note that heat-sinks.

argument, will be described as angular for 3a and 3b, rotational for 3c and 3d and linear for 3e and 3f.

In most mechanical arm designs, the whole machines can be thought of as a series of separate modules joined together. Basically a set of rods connect mechanisms that bend, turn or twist. In the case of a linear motion the rod itself expands and contracts.

Consider, as an example, the human arm, a shoulder, upper arm, elbow, forearm and wrist (**figure four**). The shoulder is in effect two angular joints: the upper arm can swing backwards and forwards, and also up and down.

## Arm flexibility

These two degrees of freedom are not separately hinged, but are produced by a ball-and-socket mechanism. The vertical swing is about 180 degrees and the horizontal 160. The shoulder can also move up and down a couple of inches and forward and backward a small distance.

Upper arm rotation, between the shoulder ball and socket and the elbow joint, is about 100 degrees, elbow bend is about 120 degrees. There is a rotation between elbow and wrist of nearly 180 degrees.

True rotations about a plane are unknown in nature, since it would be impossible to get nerve and blood vessel continuity across the joint.

The wrist motion of about 90 degrees up and down and 50 degrees from side to side leads onto the hand (which has about 19 further degrees of freedom) giving a total of nine

degrees of freedom on the arm. This is not including the fact that the torso can be rotated and bent to either side and forwards.

The total volume covered by at one arm of the pair is a hemisphere, a little squashed at the front, of about 2ft 6in, plus a very limited area round the back. Both hands can work together only in the central 'slice' of that total volume.

The motor is muscle — a pulling device — and hence muscles come in pairs, one to flex the joint and the second to pull it back. Hydraulic and pneumatic cylinders (**3b, 3d and 3f**) can be made to pull and push, by feeding pressurised fluid in at the ends, either side of the pressure seal.

One form of industrial robot that includes all three types of motion is typified by the Unimate series 4000 arm (see photograph two, last month, and **figure five**).

Base rotation is a maximum of 200 degrees (65 degree/second), maximum vertical stroke is 50 degrees (35 degrees/second), maximum extension is 1300mm (750mm/second from 1608mm to 2929mm). Wrist bend, swivel and yaw are 230 degrees, 300 degrees and 200 degrees respectively, all with a maximum rate of 110 degrees/second.

This arm has a maximum load carrying capability of up to 175kg and a positional accuracy of 2mm.

Compare that, if it is possible, to the plastic arm in **photograph eight**. Compressed air has been replaced by d.c. motors and the joints are held in position by worm-drive gears. It is shown as a warning to all those who think arm design is trivial: only two of five designed degrees of freedom were ever built.

Notwithstanding photograph seven, electric motors are still probably the most suitable power source for small arm design (see: Scheinman 69 pp17-20), if they are sufficiently geared down to generate the high turning forces required.

Fortunately the largest and most powerful motors are also those most inboard — nearest the shoulder. In some designs, including **photograph eight** their weight can be used to counterbalance the weight of the remainder of the arm.

In many designs, the motors are not always at the joint; instead, the power is transmitted from the electric motors to the joint by wires, belts (toothed or untoothed), gears, steel ribbon or chains working over pulleys.

Smaller amounts of power can be transmitted over short distances by cables inside tubes, either rotational — like a speedometer or tachometer cable on a car, or pulling as is found in bicycle brake cables.

Great care is needed in the design of pulley-type mechanisms when power is taken over an intermediate joint between the power source and the joint to be moved. It is important that movement in that intermediate joint does not affect the driven joint. Attempts to compensate for this in software can be grim business, involving considerable computational expense.

Keith Baxter and Timothy Daily (Baxter and Daly 79) describe a design in which a five degree of freedom arm is constructed with all the power transmitted from small electric motors at the base to the joints via belts manufactured from neoprene O-ring cord over a series of plastic pulleys.

## Strong enough for chess

Total reach was just over one foot with a lifting capacity of about ½ ounce — enough to lift board-game pieces (chessmen, draughts etc). Sensing may be provided by measuring the rotation of the drive pulleys. This is not the most satisfactory arrangement as one major source of error in this layout would be stretch and slip in the rubber drive cables.

Angular joints (**3a**) may be driven in several ways. An electric motor may be mounted to the inner extension and its output shaft connected directly to the outer rod. Any play in the reduction gearing on the motor will be magnified manifold, hence high-precision gearboxes are needed.

By careful motor selection, ample torque can be applied at the required speed, although care should be taken to limit the rotation of the joint so as not to stress either the hinge or any cable or wires that may be going further down the arm.

The inherent simplicity of this design is counteracted by the weight of the motor, which imposes a severe mechanical disadvantage to the drives on previous degrees of freedom.

To overcome this, the motor may be placed at the most inboard end of the design, but the resulting pulley and cable mechanism adds further mechanical complexity and is another source of play in the system.

**Figure 3b** shows a piston used to provide power. Mechanical disadvantage may easily be calculated from the pivot positions along the arm lever — it is, however, the basis of the human arm — and that seems to function well enough.

An alternative fluid-drive motive source is shown in **photograph seven**. In the centre of the picture is a pneumatic vane motor. Pressurised air (at about 80 psi) is fed to the two inputs and

*continued over page*

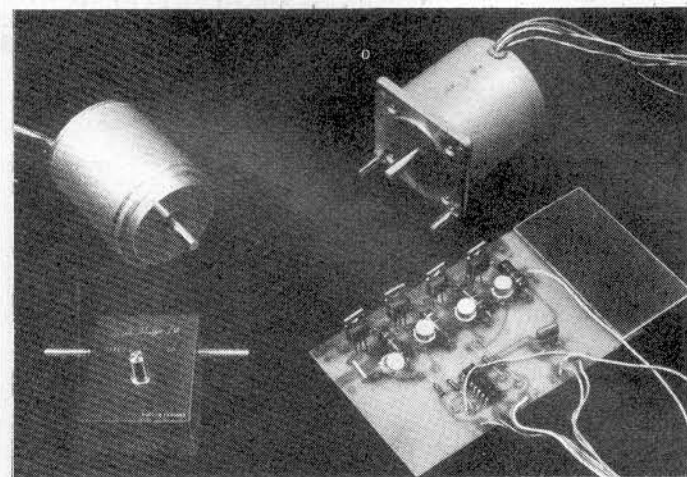

**Picture 6:** Two stepper motors and power drive circuit for any four-phase motor. The gearbox is a 60:1 worm-drive mechanism.

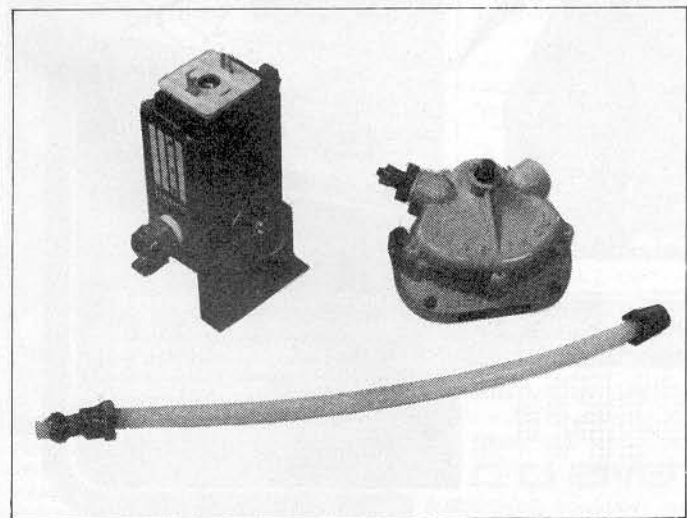

**Picture 7:** Fluid drive motor using compressed air at around 80 psi. Input is through the two horizontal pipes; drive from the vertical shaft. Also shown is the on/off solenoid valve.

From previous page

the difference in pressure between the two supplies positions the vane inside the triangular body accordingly. Output power is taken from the shaft at the top of the casing.

Also shown in the photograph is a solenoid valve for allowing or interrupting the air flow using an electric control current. Its working speed is of the order of milliseconds. Rotation is limited to 90 degrees, but these motors come in a range of sizes. The area of the vane, coupled with the maximum air pressure useable, dictates the torque rating of the device.

One disadvantage of using compressed air in this way is the need for compressed air itself. Most engineering laboratories and workshops will have a pressure line piped around the area, but work elsewhere will need compressors. Those that deliver 80-100 psi at a reasonable flow rate are both bulky and expensive.

Rotations (3c and 3d) can be accomplished by attaching the arm extension directly to the output shaft of an electric or fluid-vane motor. A linear motion can be converted to a rotary one, as in figure 3d, which is similar to the arrangement used to drive car windscreen wipers. A piston could be used to push a rack gear — with the pinion on the shaft.

Linear motions can be produced by electric motors driving a rack and pinion gear (3e), or a lead-screw mechanism. Lead-screws, like worm drives, offer a high resistance to displacement when the motor is not driving them, and this might be a useful feature, particularly if power was at a premium or if one does now wish continually to servo the position of that joint.

Fluid power can be used, as in figure 3f, or the whole extension can be fashioned from a pneumatic or hydraulic cylinder. A piston with square or oval cross-section will prevent a

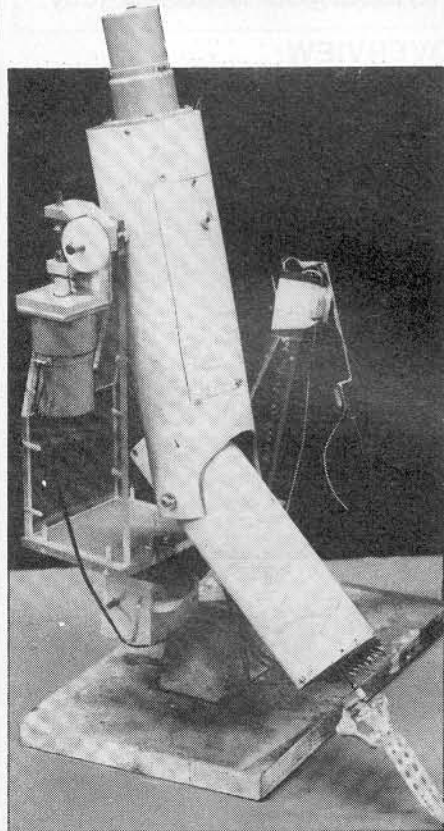

Picture 8: Be warned: arm design is no joke! This complex-looking machine achieved only two of its five designed degrees of freedom.

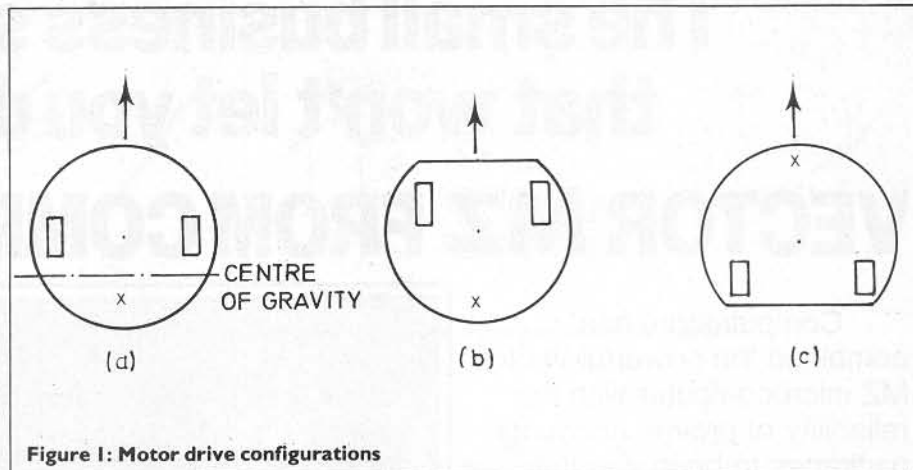

Figure 1: Motor drive configurations

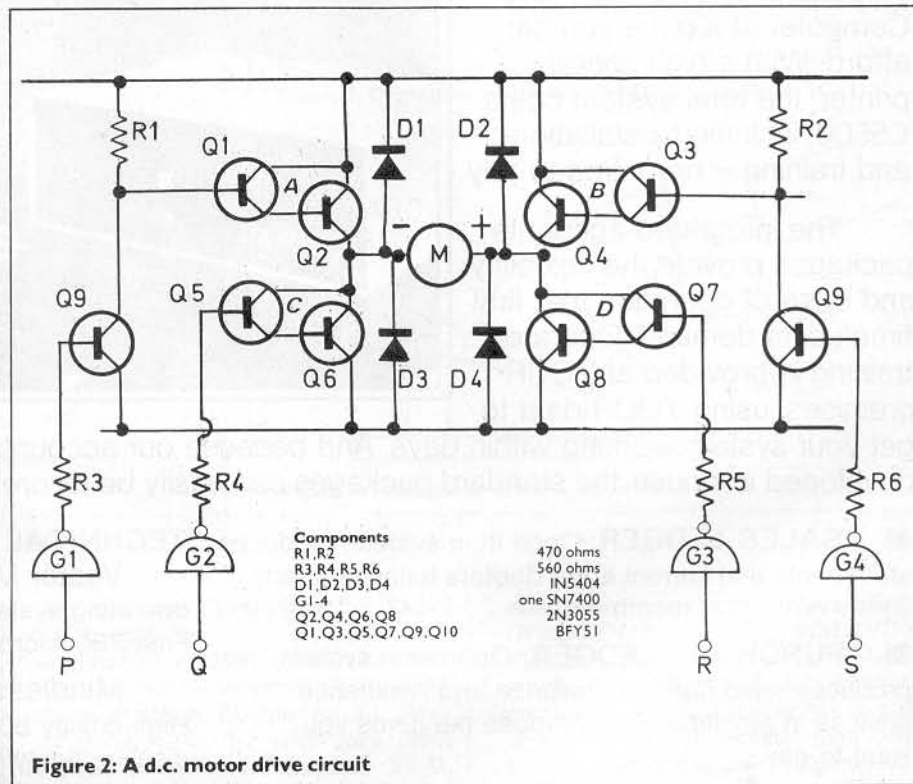

Figure 2: A d.c. motor drive circuit

further, unwanted, rotational degree of freedom being inadvertently introduced.

Grippers and hands are usually formed from a pincer-type of motion that seize the object to be manipulated between two jaws. These will often be designed so as to remain parallel to each other as they close, using some straightforward parallelogram linkage.

### All thumbs

'Human'-like hand designs are rare, even though a design with two fingers and an opposing thumb would show advantages over the straight gripper. It is standard industrial robot practice to bolt specialist tools onto the wrist joint: spanners for doing up bolts, hooks, magnets or suckets for lifting things and so on.

Experimentation is essential in robotics and new ideas are always being tested. The 'ORM' arm is constructed from a series of circular plates with a number (eight in this case) of pneumatic actuators between the plates. Figure 6 shows the principle of the device. (Roth *et al* 1973).

There were problems with the construction and control of this form of manipulator, but it could well form the basis of an even better idea. It is obvious that the human arm might form the basis of a computer-controlled manipulator, and that the study of quadruped locomotion would assist with the study of motion in a four-legged walking machine.

One might wonder, therefore, if nature has any other interesting and fun designs to research. Mechanical insects, dinosaurs, crabs, starfish and assorted creatures from ancient mythology have all been discussed as likely candidates by various members of the laboratory.

The Japanese Active Cord Mechanism (Hirose and Umetani 76) is a highly articulated robot with a long, thin body and is based on that team's study of snake locomotion. It shows some interesting properties.

Part Three of this series will be concerned with the design of robot sensors and sensory systems, and how this information is fed into microprocessors.

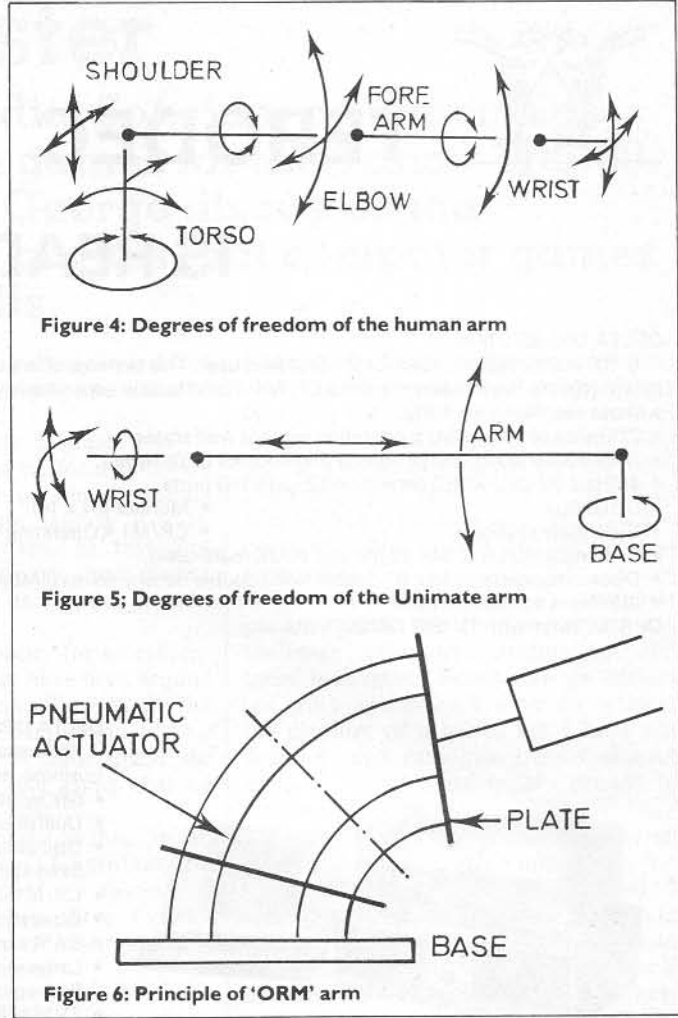
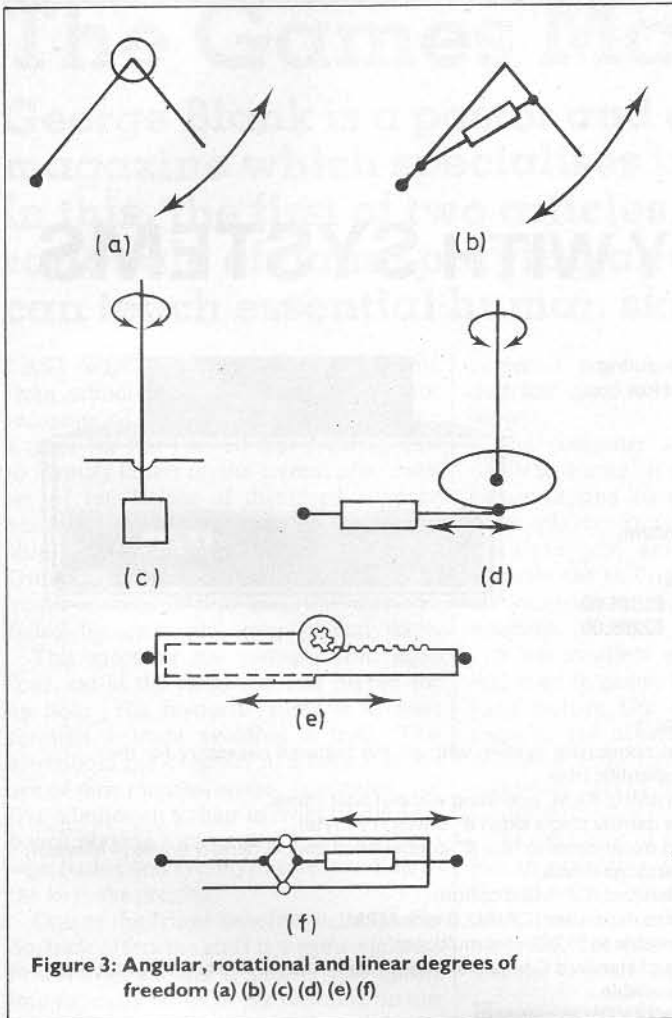

## References

Baxter K. and Daily T. (1979): *A hobbyist robot arm* in: Byte 4-2 (February 1979)

Burckhardt C. W. and Helms D. (1976): *Some general rules for building robots* in Proceedings of the Third Conference on Industrial Robot Technology and Sixth International symposium on Industrial Robots. Held at Nottingham University, March 24-26th, 1976, ppE4-49 to E4-58; Bedford, England, International Fluidics Services.

CISM-IFTToMM (1973) (organisers): *On theory and practice of robots and manipulators*. Proceedings of First CSIM-IFTToMM symposium at Udine 1973; Springer-Verlag, Vienna-New York. Two volumes, ISBN 3-211-81252-0 and ISBN 0-387-81252-0.

CISM-IFTToMM (1976) (organisers), Morecki A. and Kedzior K. (eds): *Theory and practice of robots and manipulators*, Proceedings of Second CSIM-IFTToMM symposium at Warsaw 1976; PWN — Polish Scientific Publishers/Elsevier Scientific Publishing Co, Amsterdam-Oxford-New York. One volume, ISBN 0-444-99812-8.

Computabits (1979a) (Hampshire N., Ed): *Using KIM-1 to aid motor control*

in: *Practical Computing* 2-4 (April 1979), pp90-96.

Computabits (1979b) (Hampshire N., Ed): *Stepper motor control using KIM-1*, in *Practical Computing* 2-5 (May 1979) pp91-99; 3-1 (February 1980)

Dobrotin B. M. and Scheinman V. D. (1973): *Design of a computer controlled manipulator for robot research*, in: Third international joint conference on artificial intelligence at Stanford University, Calif, 20-23rd August, 1973 pp324-335. Stanford Research Institute (Publication Dept.), advance papers.

Giacomo P. (1979): *A Stepper motor primer: Part 1: Theory of operation* in: Byte 4-2 (February 1979) pp90-105 and Part 2: *Interfacing and other considerations* in: Byte 4-3 (March 1979)

Heiserman D. L. (1976): *Build your own working robot*, Slough, England: Foulsham-Tab Ltd. ISBN 0-7042-0171-2.

Hirose S. and Umetany Y. (1976): *Kinematic control of active cord mechanism with tactile sensors*, in CSIM-IFTToMM (1976), pp241-252.

Hollis R. (1977) *Newt: A mobile, cognitive robot* in Byte 2-6 (June 1977)

Kato I., Ohteru S., Kobayashi H., Shirai K. and Uchiyama A.: *Inform-*

*ation-power machine with senses and (WABOT-1)* in CISM-IFTToMM (1973), Volume 1, pp11-24.

Lewis R. A. and Bejczy A. K.: *Planning considerations for a roving robot with arm* in Third international joint conference on artificial intelligence at: Stanford University, Calif., 20-23rd August, 1973 pp308-316 Stanford Research Institute (Publications Dept) advance papers.

Loofbourrow T.: *How to build a computer-controlled robot*. New Jersey: Hayden Book Co Inc, ISBN 0-8104-5681-8.

Roth B., Rastegar J. and Scheinman V.: *On the design of computer-controlled manipulators* in: CISM-IFTToMM (1973); Volume 1, pp93-113.

Scheinman V. D. (1969): *Design of a computer-controlled manipulator*. Stanford Artificial Intelligence project MEMO-AIM-92. University of Stanford, Computer Sciences Dept.

Smith M. H. (1973): *Design of a low-cost, general-purpose robot* in: Third international joint conference on artificial intelligence at Stanford University 20-23rd August, 1973, pp324-335.

Young J. F. (1973): *Robotics*. London: Butterworth ISBN 0-7042-0171-2.